

INSTRUCTION MANUAL

BS09421904

2

Mounting Template

Place the mounting template horizontally against the wall at suitable height. Take the mounting hole in the base as benchmark and drill four $\Phi 8$ holes on the wall. (Attention that the four holes are on the same level.)

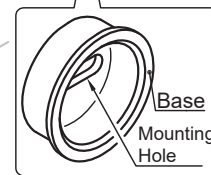

3

$\Phi 8$ Hole

Anchor

Self-tapping Screw

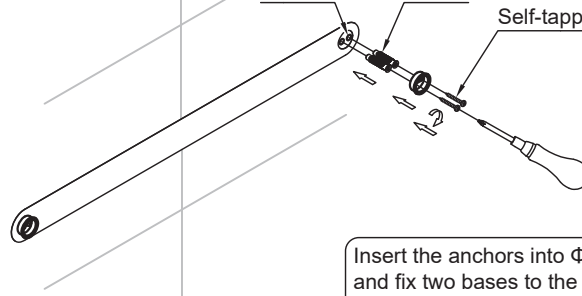

Insert the anchors into $\Phi 8$ Hole, and fix two bases to the wall by using self-tapping screws.

4

Towel bar

Set Screw

Wrench

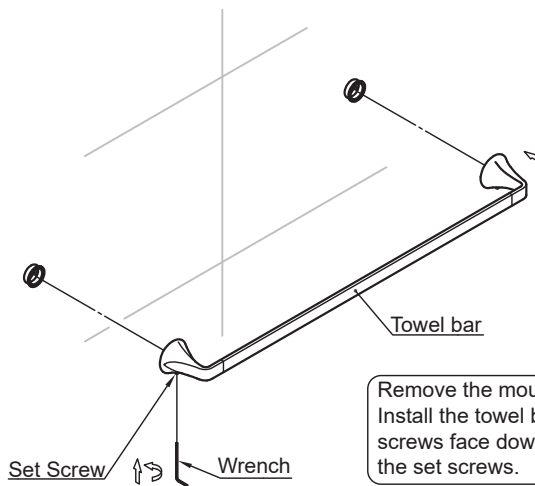

Remove the mounting template. Install the towel bar with the set screws face downwards. Tighten the set screws.

5

When finished, double check if the installation is correct.

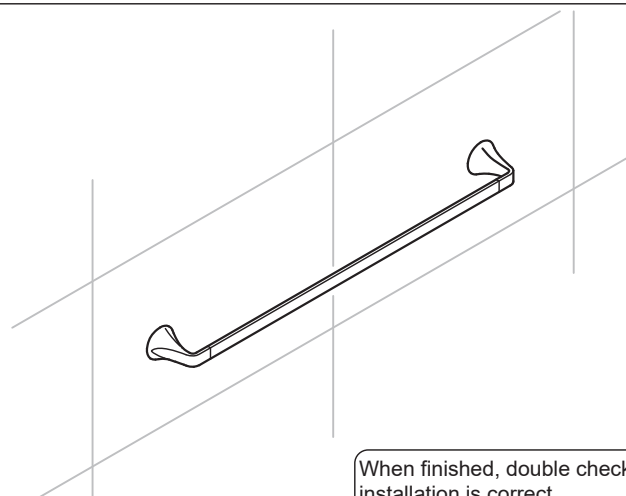

I. Installation Notice

- 1.The product Shelf should be installed only after the completion of house interior decoration in case paint or other chemicals erode the surface.
- 2.After installation, check all the joints to make sure they are firmly connected. After that, the product is ready for normal use.
- 3.Keep the manual to the user.

II. Operation Notice

- 1.Do not hang heavy things on the product.
- 2.Clean the surface of the product regularly to keep it glossy. Note: Please do not use inappropriate tools such as sharp brushes, rough sponges, scouring pads or corrosive detergent. And it is not recommended to use the detergent sold in the market, because its formula changes frequently. Please clean the mixer with wet cloth and soapy water after some time of usage. Then rinse the soap off with clean water and dry with a soft cotton cloth.
- 3.Residue left by shampoo, shower gel, hair dye, perfume, shaving water, nail polish, toothpaste could cause damage to the product. Clean it with water to wash off residue after using. Detergent and chemicals cannot be placed under the product as volatile gas could damage the product.
- 4.Do not disassemble the product without help from the professionals.

III. Steps (Fig.1-5):

* The installation diagram is only for reference. The product is subject to the real object.

1

Prepare and check the following tools.

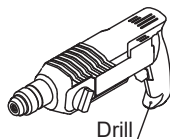

Drill



Goggles



Pencil

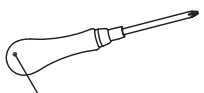

Philips Screwdriver



Locating Plate (supplied)

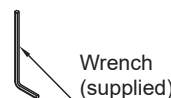

Wrench (supplied)